

[www.weldoninstruments.com](http://www.weldoninstruments.com)

PROVEEDOR EXCLUSIVO:



Vaginal Specula

Vaginal Retractors

Uterine Curette & Scoops

Obstetrical Forceps

385 - 424

# Gynecology

Gynecology

Ginecologia

Gynakologie



WS-385-001  $\varnothing$  25 mm  
 WS-385-002  $\varnothing$  30 mm  
 WS-385-003  $\varnothing$  35 mm

Fergusson  
 Metal Specula  
 Tubular Shape

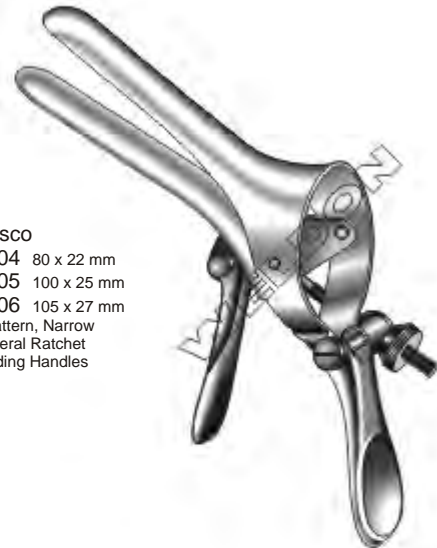

Cusco  
 WS-385-004 80 x 22 mm  
 WS-385-005 100 x 25 mm  
 WS-385-006 105 x 27 mm  
 Swiss Pattern, Narrow  
 With Lateral Ratchet  
 With Folding Handles



Cusco  
 WS-385-007  
 75 x 17 mm  
 Conical Shape, Virgin Size



Cusco  
 WS-385-008 75 x 32 mm  
 WS-385-009 85 x 35 mm  
 WS-385-010 100 x 35 mm  
 Vaginal Specula With Lateral  
 Ratchet, With Folding Handles  
 WS-385-011 85 x 35 mm  
 With Interchangeable Fiber Optic Light Carrier

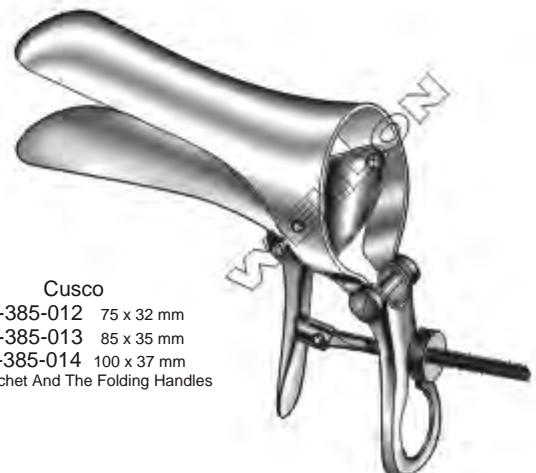

Cusco  
 WS-385-012 75 x 32 mm  
 WS-385-013 85 x 35 mm  
 WS-385-014 100 x 37 mm  
 With Ratchet And The Folding Handles

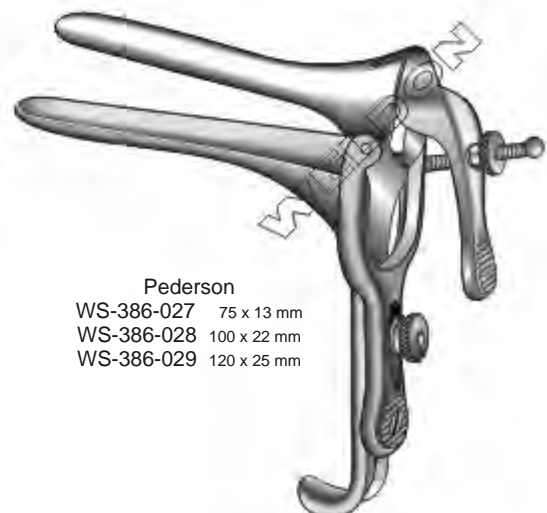
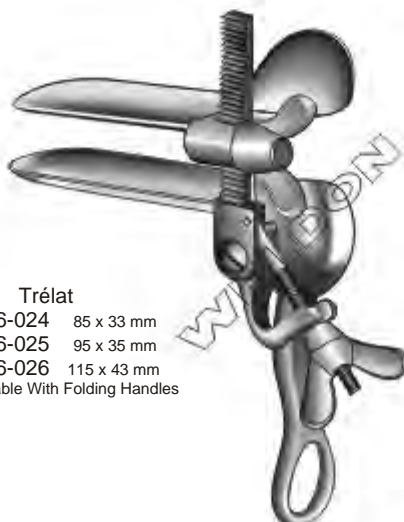
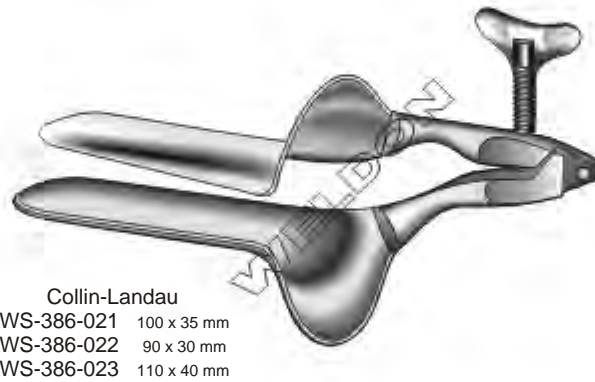
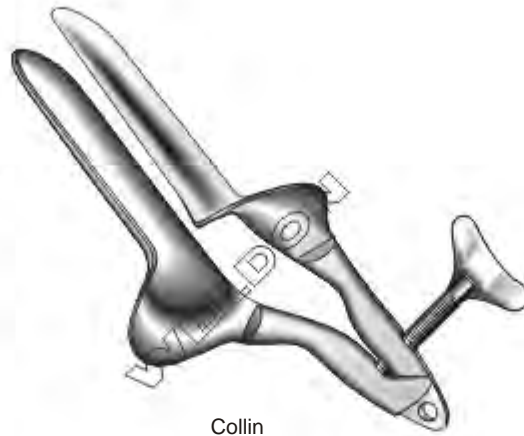
**Vaginal Specula | Espéculos Vaginales | Vaginalspekula**

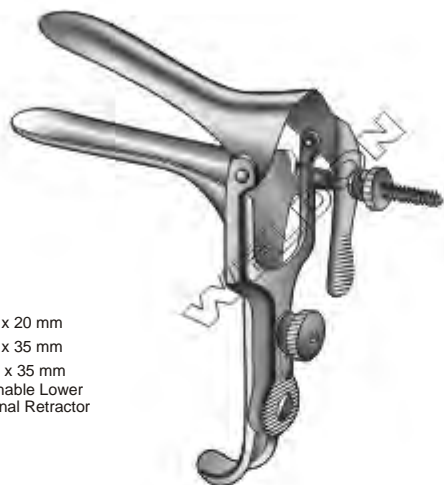

**Grave**  
 WS-387-030 75 x 20 mm  
 WS-387-031 95 x 35 mm  
 WS-387-032 115 x 35 mm  
 With Lateral Ratchet, Detachable Lower Blade, Convertible Into Vaginal Retractor

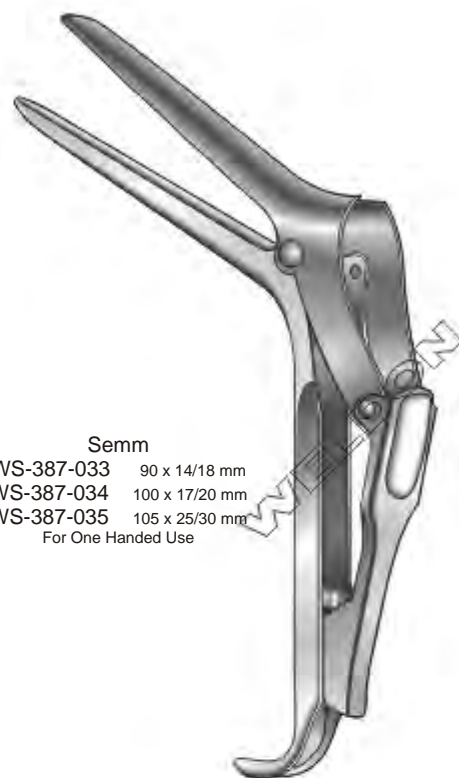

**Semm**  
 WS-387-033 90 x 14/18 mm  
 WS-387-034 100 x 17/20 mm  
 WS-387-035 105 x 25/30 mm  
 For One Handed Use

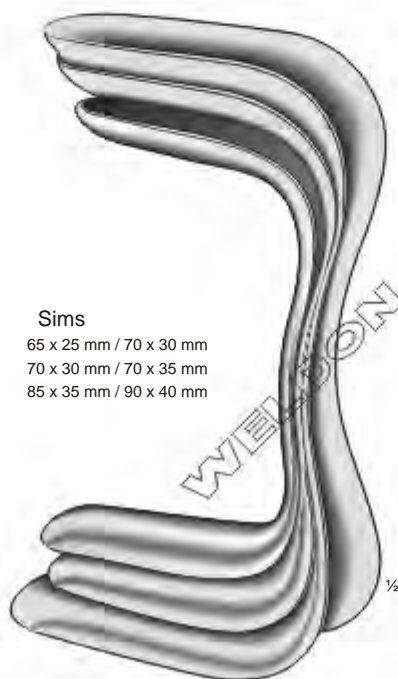

**Sims**  
 WS-387-036 65 x 25 mm / 70 x 30 mm  
 WS-387-037 70 x 30 mm / 70 x 35 mm  
 WS-387-038 85 x 35 mm / 90 x 40 mm

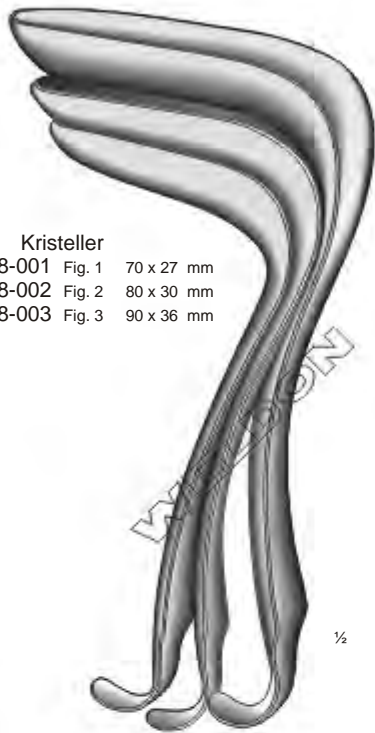

**Jackson**  
 WS-387-039 75 x 35 mm  
 WS-387-040 90 x 35 mm  
 WS-387-041 100 x 35 mm  
 WS-387-042 75 x 40 mm  
 WS-387-043 90 x 40 mm  
 WS-387-044 100 x 40 mm

**Vaginal Retractors | Valvas Vaginales | Scheidenhalter**

**Kristeller**  
 WS-388-001 Fig. 1 70 x 27 mm  
 WS-388-002 Fig. 2 80 x 30 mm  
 WS-388-003 Fig. 3 90 x 36 mm

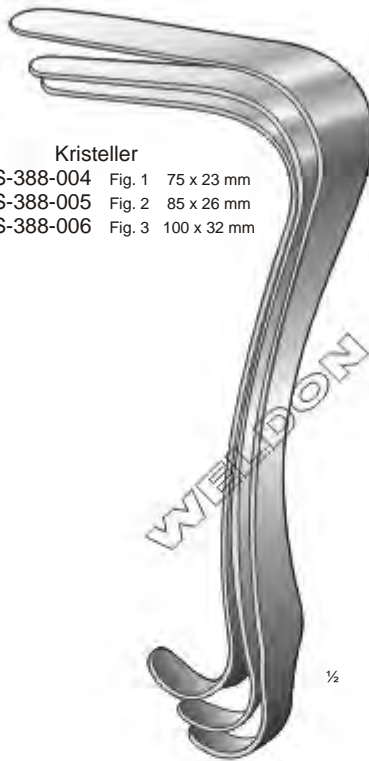

**Kristeller**  
 WS-388-004 Fig. 1 75 x 23 mm  
 WS-388-005 Fig. 2 85 x 26 mm  
 WS-388-006 Fig. 3 100 x 32 mm



**Kristeller**  
 WS-388-007 Fig. 1  
 WS-388-008 Fig. 2  
 WS-388-009 Fig. 3  
 Set of 1 Speculum And  
 1 Retractor Each

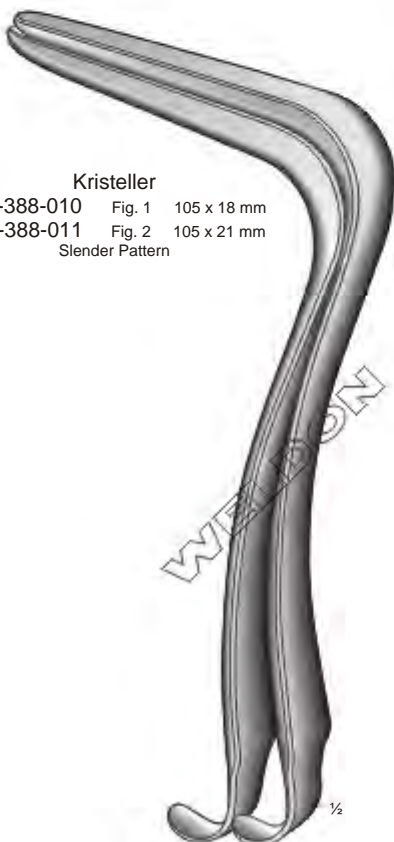

**Kristeller**  
 WS-388-010 Fig. 1 105 x 18 mm  
 WS-388-011 Fig. 2 105 x 21 mm  
 Slender Pattern

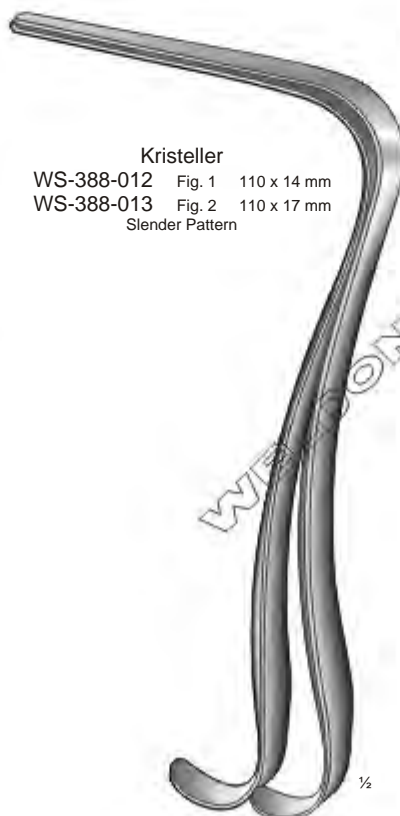

**Kristeller**  
 WS-388-012 Fig. 1 110 x 14 mm  
 WS-388-013 Fig. 2 110 x 17 mm  
 Slender Pattern



**Kristeller**  
 WS-388-014 Fig.1+1  
 WS-388-015 Fig.2+2  
 Set of 1 Speculum & 1 Retractor

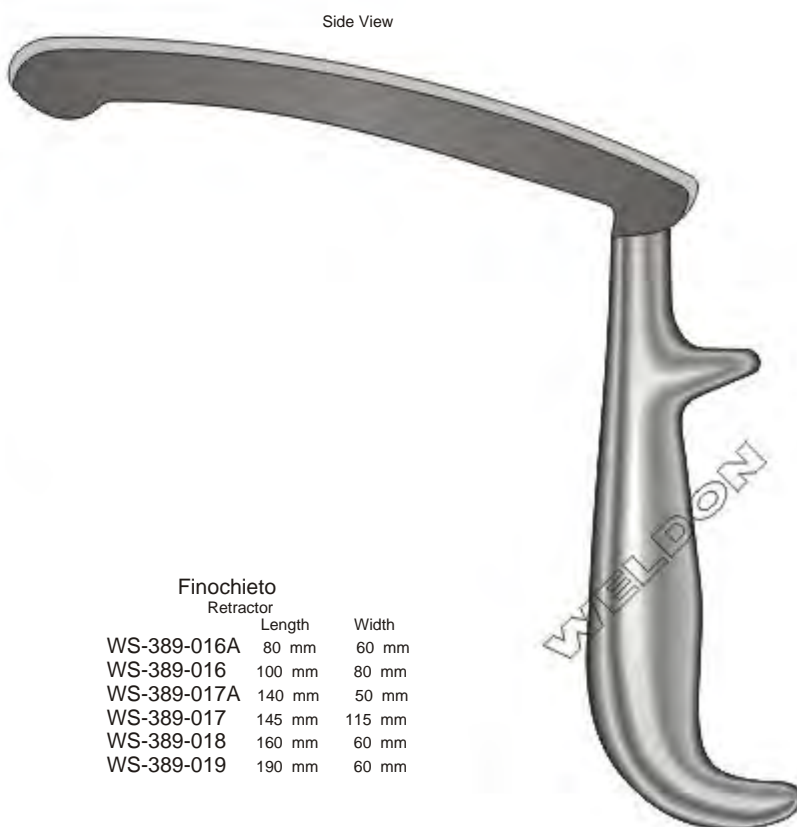

Finochieto  
Retractor

	Length	Width
WS-389-016A	80 mm	60 mm
WS-389-016	100 mm	80 mm
WS-389-017A	140 mm	50 mm
WS-389-017	145 mm	115 mm
WS-389-018	160 mm	60 mm
WS-389-019	190 mm	60 mm



**Doyen**

	Fig	a mm	b mm
WS-390-031	1	75	45
WS-390-032	2	90	45
WS-390-033	3	110	45

WS-390-020 Fig. 1 55 x 35 mm  
 WS-390-021 Fig. 2 85 x 35 mm  
 WS-390-022 Fig. 3 115 x 35 mm

WS-390-023 Fig. 1 55 x 45 mm  
 WS-390-024 Fig. 2 85 x 45 mm  
 WS-390-025 Fig. 3 115 x 45 mm  
 WS-390-026 Fig. 4 160 x 45 mm

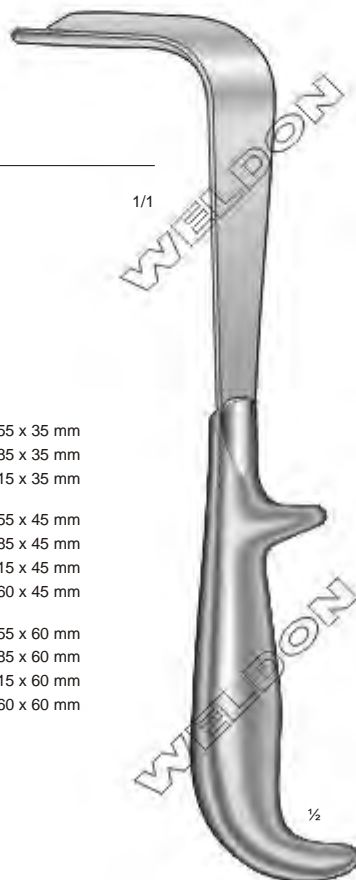
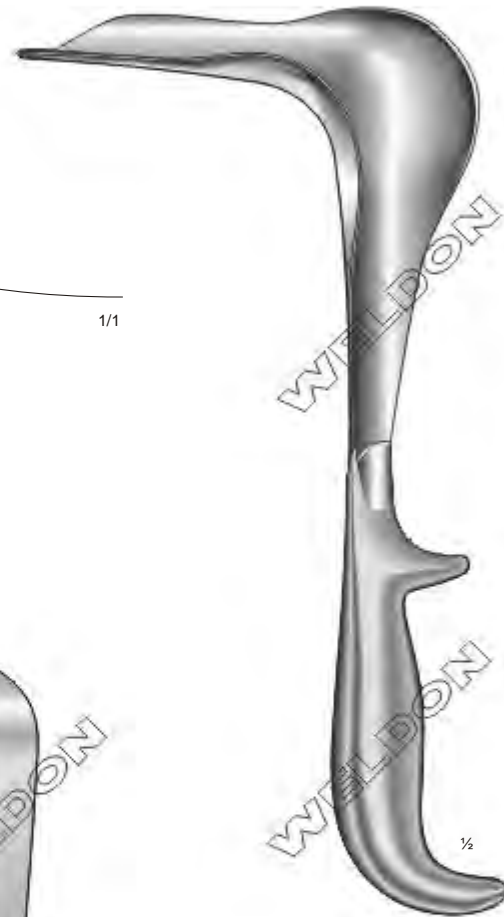
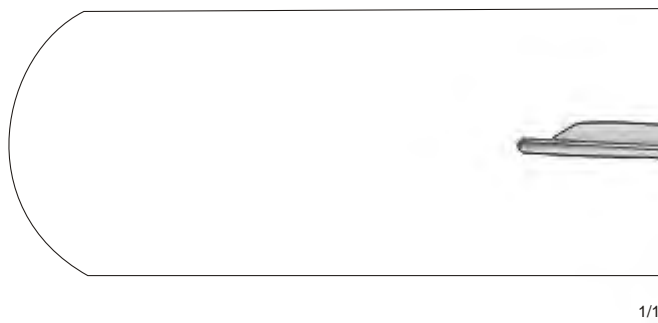
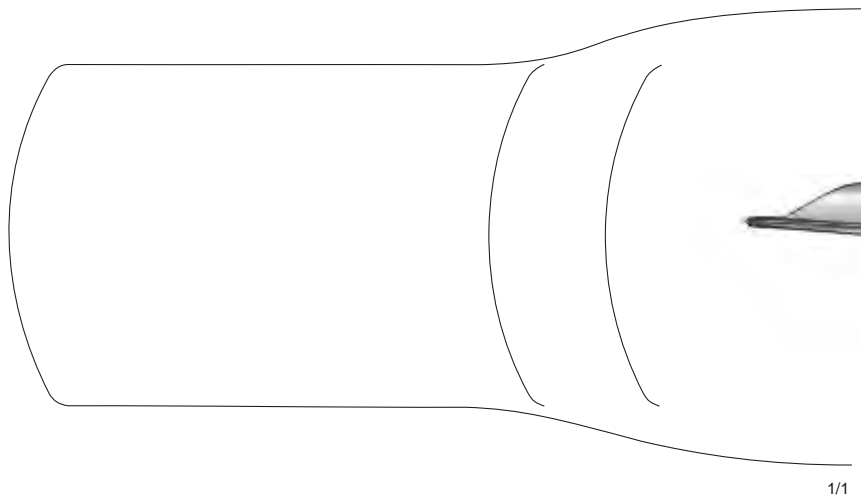
WS-390-027 Fig. 1 55 x 60 mm  
 WS-390-028 Fig. 2 85 x 60 mm  
 WS-390-029 Fig. 3 115 x 60 mm  
 WS-390-030 Fig. 4 160 x 60 mm  
 Slightly Concave

**Doyen**



**Kallmorgen Specula**  
 WS-391-034 70 x 40 mm, Fig. 1  
 WS-391-035 90 x 40 mm, Fig. 2  
 18.5 cm / 7¼"



**Kallmorgen Retractor**  
 WS-391-036 70 x 33 mm, Fig. 1  
 WS-391-037 90 x 33 mm, Fig. 2  
 18.5 cm / 7¼"



**Kallmorgen**  
 WS-391-038 Fig. 1+1  
 WS-391-039 Fig. 2+2  
 Set Of Two



**Eastman**  
 WS-391-040 75 x 38 mm  
 WS-391-041 90 x 38 mm  
 WS-391-042 100 x 38 mm  
 17 cm / 6¾"



**Vaginal Retractors | Valvas Vaginales | Scheidenhalter**

**Kristeller**  
 WS-392-043 Fig.0 - 110 x 20 mm  
 WS-392-044 Fig.1 - 110 x 27 mm  
 WS-392-045 Fig.2 - 110 x 30 mm  
 WS-392-046 Fig.3 - 110 x 36 mm  
 23 cm / 9"  
 For Virgins, Vienna Pattern



**Kristeller**  
 WS-392-047 Fig.0 - 115 x 17 mm  
 WS-392-048 Fig.1 - 115 x 23 mm  
 WS-392-049 Fig.2 - 115 x 26 mm  
 WS-392-050 Fig.3 - 115 x 32 mm  
 23 cm / 9"  
 Vienna Pattern



**Mathieu**  
 WS-392-051 Fig.1 - 100 x 13-23 mm  
 WS-392-052 Fig.2 - 100 x 17-30 mm  
 20 cm / 8"



**Mathieu**  
 WS-392-053 Fig.1 - 100 x 11-21 mm  
 WS-392-054 Fig.2 - 100 x 15-27 mm  
 20 cm / 8"



**Matzenauer**  
 WS-392-055 90 x 20 mm  
 WS-392-056 100 x 10 mm  
 WS-392-057 100 x 15 mm  
 WS-392-058 100 x 20 mm  
 WS-392-059 100 x 25 mm  
 WS-392-060 110 x 25 mm  
 WS-392-061 110 x 30 mm  
 WS-392-062 120 x 10 mm  
 WS-392-063 120 x 15 mm  
 WS-392-064 120 x 20 mm  
 WS-392-065 120 x 25 mm  
 WS-392-066 120 x 30 mm  
 WS-392-067 120 x 35 mm  
 WS-392-068 130 x 20 mm  
 WS-392-069 130 x 25 mm  
 WS-392-070 130 x 30 mm  
 WS-392-071 130 x 35 mm  
 WS-392-072 130 x 40 mm

22 cm / 8 3/4"



**Landau**  
 WS-393-073 100 x 28 mm  
 WS-393-074 110 x 38 mm  
 29 cm / 11<sup>3</sup>/<sub>8</sub>"



**Breisky**  
 32 cm / 12<sup>1</sup>/<sub>2</sub>" - 42 cm / 16<sup>1</sup>/<sub>2</sub>"  
 Vienna Pattern

- WS-393-075 130 x 20 mm
- WS-393-076 130 x 25 mm
- WS-393-077 130 x 30 mm
- WS-393-078 130 x 35 mm
- WS-393-079 130 x 40 mm
- WS-393-080 140 x 35 mm
- WS-393-081 140 x 40 mm
- WS-393-082 140 x 45 mm
- WS-393-083 150 x 25 mm
- WS-393-084 150 x 30 mm
- WS-393-085 150 x 35 mm
- WS-393-086 155 x 40 mm
- WS-393-087 160 x 30 mm
- WS-393-088 160 x 45 mm
- WS-393-089 170 x 30 mm
- WS-393-090 170 x 35 mm
- WS-393-091 180 x 40 mm
- WS-393-092 200 x 25 mm
- WS-393-093 220 x 25 mm
- WS-393-094 220 x 35 mm
- WS-393-095 220 x 40 mm
- WS-393-096 240 x 20 mm



**Breisky**  
 28 cm / 11" - 31 cm / 12<sup>1</sup>/<sub>8</sub>"  
 Vienna Pattern

- WS-393-097 80 x 25 mm
- WS-393-098 90 x 25 mm
- WS-393-099 100 x 10 mm
- WS-393-100 100 x 15 mm
- WS-393-101 100 x 20 mm
- WS-393-102 100 x 25 mm
- WS-393-103 100 x 30 mm
- WS-393-104 100 x 35 mm
- WS-393-105 100 x 40 mm
- WS-393-106 110 x 20 mm
- WS-393-107 110 x 25 mm
- WS-393-108 110 x 30 mm
- WS-393-109 120 x 10 mm
- WS-393-110 120 x 15 mm
- WS-393-111 120 x 20 mm
- WS-393-112 120 x 25 mm
- WS-393-113 120 x 30 mm
- WS-393-114 120 x 35 mm
- WS-393-115 120 x 40 mm



Doyen  
WS-394-116  
24 cm / 9½"



Auvard  
WS-394-117  
24 cm / 9½"



Auvard  
WS-394-118  
24 cm / 9½"

Uterine Dilators | Dilatores Uterinos | Uterusdilatoren



**Hegar**  
Single Ended  
Pieces Per Set  
WS-395-001 14 4 - 17 mm  
WS-395-002 26 1 - 26 mm

	Ø mm		Ø mm
WS-395-003	1.0	WS-395-024	11.5
WS-395-004	1.5	WS-395-025	12.0
WS-395-005	2.0	WS-395-026	12.5
WS-395-006	2.5	WS-395-027	13.0
WS-395-007	3.0	WS-395-028	13.5
WS-395-008	3.5	WS-395-029	14.0
WS-395-009	4.0	WS-395-030	14.5
WS-395-010	4.5	WS-395-031	15.0
WS-395-011	5.0	WS-395-032	15.5
WS-395-012	5.5	WS-395-033	16.0
WS-395-013	6.0	WS-395-034	16.5
WS-395-014	6.5	WS-395-035	17.0
WS-395-015	7.0	WS-395-036	17.5
WS-395-016	7.5	WS-395-037	18.0
WS-395-017	8.0	WS-395-038	19.0
WS-395-018	8.5	WS-395-039	20.0
WS-395-019	9.0	WS-395-040	21.0
WS-395-020	9.5	WS-395-041	22.0
WS-395-021	10.0	WS-395-042	23.0
WS-395-022	10.5	WS-395-043	24.0
WS-395-023	11.0	WS-395-044	25.0
		WS-395-045	26.0

	Ø mm
WS-395-003A	1.0
WS-395-004A	1.5
WS-395-005A	2.0
WS-395-006A	2.5
WS-395-007A	3.0
WS-395-008A	3.5
WS-395-009A	4.0
WS-395-010A	4.5
WS-395-011A	5.0
WS-395-012A	5.5
WS-395-013A	6.0
WS-395-014A	6.5
WS-395-015A	7.0
WS-395-016A	7.5
WS-395-017A	8.0
WS-395-018A	8.5
WS-395-019A	9.0
WS-395-020A	9.5
WS-395-021A	10.0
WS-395-022A	10.5
WS-395-023A	11.0
WS-395-024A	11.5
WS-395-025A	12.0
WS-395-026A	12.5
WS-395-027A	13.0
WS-395-028A	13.5
WS-395-029A	14.0
WS-395-030A	14.5
WS-395-031A	15.0
WS-395-032A	15.5
WS-395-033A	16.0
WS-395-034A	16.5
WS-395-035A	17.0
WS-395-036A	17.5
WS-395-037A	18.0
WS-395-038A	18.5
WS-395-039A	19.0
WS-395-040A	19.5
WS-395-041A	20.0
WS-395-042A	20.5
WS-395-043A	21.0
WS-395-044A	21.5
WS-395-045A	22.0
WS-395-046A	22.5
WS-395-047A	23.0
WS-395-048A	23.5
WS-395-049A	24.0
WS-395-050A	24.5
WS-395-051A	25.0
WS-395-052A	25.5
WS-395-053A	26.0
WS-395-054A	26.5
WS-395-055A	27.0
WS-395-056A	27.5
WS-395-057A	28.0
WS-395-058A	28.5
WS-395-059A	29.0
WS-395-060A	29.5
WS-395-061A	30.0
WS-395-062A	30.5



**Hegar**  
WS-395-046 Set of 8 Dilators  
3 / 4 mm - 17 / 18 mm Ø  
WS-395-047 Set of 13 Dilators  
1 / 2 mm - 25 / 26 mm Ø  
Double Ended

	Ø mm
WS-395-048	1.0 / 2.0
WS-395-049	3.0 / 4.0
WS-395-050	5.0 / 6.0
WS-395-051	7.0 / 8.0
WS-395-052	9.0 / 10.0
WS-395-053	11.0 / 12.0
WS-395-054	13.0 / 14.0
WS-395-055	15.0 / 16.0
WS-395-056	17.0 / 18.0
WS-395-057	19.0 / 20.0
WS-395-058	21.0 / 22.0
WS-395-059	23.0 / 24.0
WS-395-060	25.0 / 26.0



**Hegar Uterine Dilators**  
With Ring Handle

**Uterine Dilators | Dilataores Uterinos | Uterusdilatoren**

**Hegar**  
**WS-396-061**  
 Set of 8 Pieces  
 From 3 / 4 mm to 17 / 18 mm Ø  
 In Boilable Canvas Roll



**WS-396-078**



**Female Catheter**  
**WS-396-076**  
 15 cm / 6"



**Rubinstein Canula**  
**WS-396-077**  
 28 cm / 11"



**WS-396-079**



**WS-396-080**



**WS-396-081**



**WS-396-082**



**WS-396-083B**  
 13 x 4 mm

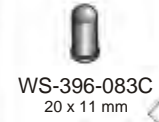

**WS-396-083C**  
 20 x 11 mm



**WS-396-083D**  
 22 x 13 mm



**Flebo Extractor**  
**WS-396-083A**  
 50 cm / 19½"  
 1.2 mm Diameter



**Pratt**  
**WS-396-062** Fig. 13/15 ( 4½ / 5 mm)  
**WS-396-063** Fig. 17/19 ( 5½ / 6½ mm)  
**WS-396-064** Fig. 21/23 ( 7 / 7½ mm)  
**WS-396-065** Fig. 25/27 ( 8½ / 9 mm)  
**WS-396-066** Fig. 29/31 ( 9½ / 10½ mm)  
**WS-396-067** Fig. 33/35 ( 11 / 11½ mm)  
**WS-396-068** Fig. 37/39 ( 12½ / 13 mm)  
**WS-396-069** Fig. 41/43 ( 13½ / 14½ mm)  
 French Scale Sizes



**Hank**  
**WS-396-070** Fig. 9/10 ( 4½ / 5 mm)  
**WS-396-071** Fig. 11/12 ( 5½ / 6 mm)  
**WS-396-072** Fig. 13/14 ( 6½ / 7 mm)  
**WS-396-073** Fig. 15/16 ( 7½ / 8 mm)  
**WS-396-074** Fig. 17/18 ( 8½ / 9 mm)  
**WS-396-075** Fig. 19/20 ( 9½ / 10 mm)  
 American Scale Sizes



Simpson  
WS-397-001  
27 cm / 10 3/4"  
Malleable  
Graduated in Inches

Simpson  
WS-397-002  
27 cm / 10 3/4"  
Rigid  
Graduated in Inches

Valleix  
WS-397-003  
28 cm / 11"  
Rigid  
Graduated in cm

Sims  
WS-397-004 Malleable  
WS-397-005 Rigid  
32 cm / 12 1/2"  
Graduated in cm

Sims  
WS-397-006 Malleable  
WS-397-007 Rigid  
33 cm / 13"  
With Probe  
Graduated in cm

Collin  
WS-397-007A  
28 cm / 11"  
Uterine Sound  
Graduated in cm

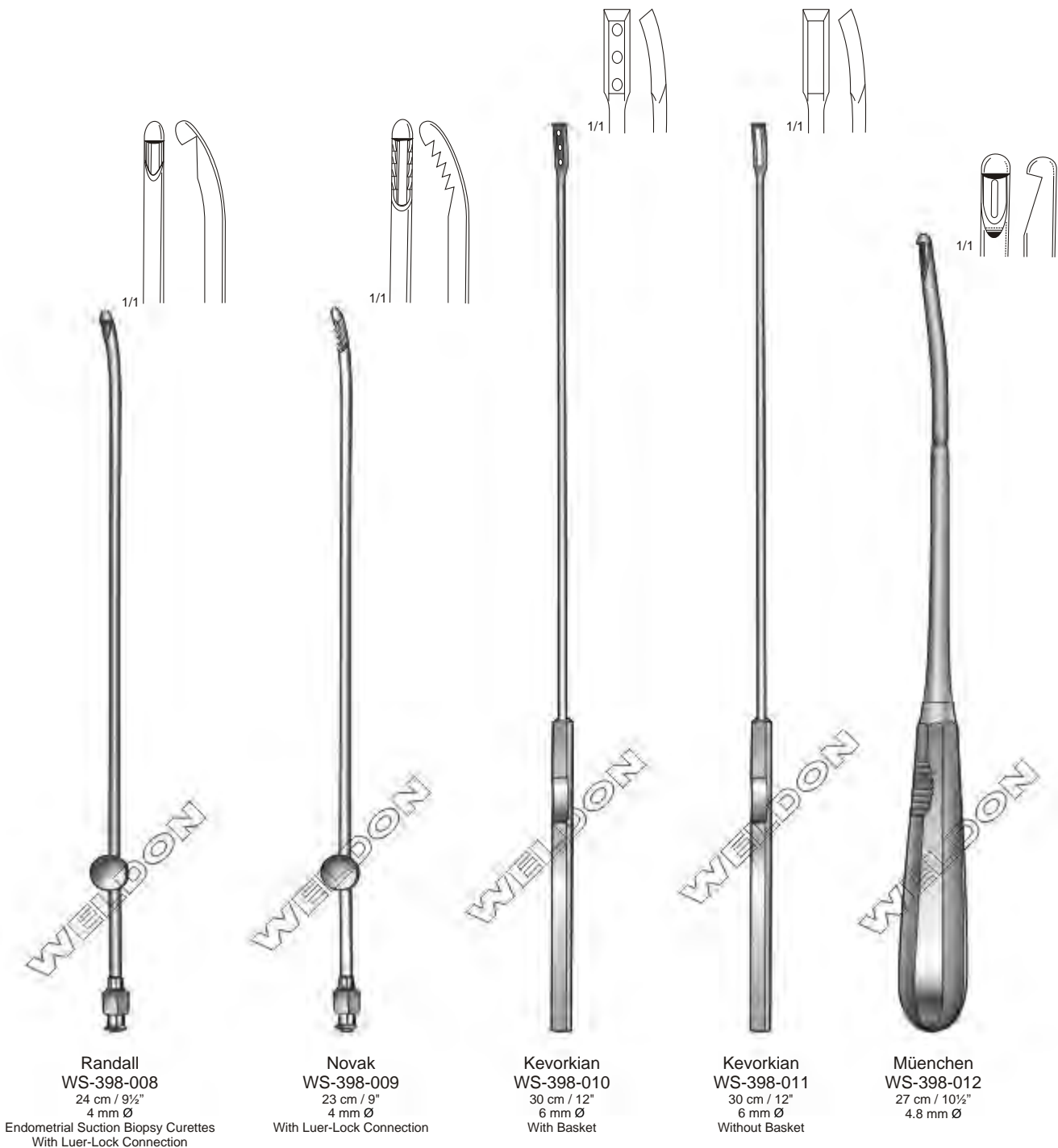
**Suction Curettes, Uterine Biopsy Curettes | Curetas Aspiradoras, Curetas Para Biopsia**  
**Saugkürretten, Biopsiekürretten**



Malleable Curettes  
[Grooved Shaft]

Rigid Curettes  
[Plain Shaft]

Recamier-Sims-Bumm  
31 cm / 12½"  
Fig.00-Fig.16  
Rigid, Sharp

Recamier-Sims-Bumm  
31 cm / 12½"  
Fig.00-Fig.16  
Malleable, Sharp

Sharp Curettes  
(Recamier Handle)

Blunt Curettes  
(Sims Handle)

Recamier-Sims-Bumm  
31 cm / 12½"  
Fig.00-Fig.16  
Rigid, Blunt

Recamier-Sims-Bumm  
31 cm / 12½"  
Fig.00-Fig.16  
Malleable, Blunt



**Uterine Curettes | Curetas Uterinas | Uterusküretten**

Fig.	Width	Rigid, Sharp	Malleable, Sharp	Rigid, Blunt	Malleable, Blunt
00	5 mm	WS-400-013	WS-400-031	WS-400-049	WS-400-067
0	6 mm	WS-400-014	WS-400-032	WS-400-050	WS-400-068
1	7 mm	WS-400-015	WS-400-033	WS-400-051	WS-400-069
2	8 mm	WS-400-016	WS-400-034	WS-400-052	WS-400-070
3	9 mm	WS-400-017	WS-400-035	WS-400-053	WS-400-071
4	11 mm	WS-400-018	WS-400-036	WS-400-054	WS-400-072
5	12 mm	WS-400-019	WS-400-037	WS-400-055	WS-400-073
6	14 mm	WS-400-020	WS-400-038	WS-400-056	WS-400-074
7	15 mm	WS-400-021	WS-400-039	WS-400-057	WS-400-075
8	16 mm	WS-400-022	WS-400-040	WS-400-058	WS-400-076
9	19 mm	WS-400-023	WS-400-041	WS-400-059	WS-400-077
10	20 mm	WS-400-024	WS-400-042	WS-400-060	WS-400-078
11	21 mm	WS-400-025	WS-400-043	WS-400-061	WS-400-079
12	23 mm	WS-400-026	WS-400-044	WS-400-062	WS-400-080
13	25 mm	WS-400-027	WS-400-045	WS-400-063	WS-400-081
14	30 mm	WS-400-028	WS-400-046	WS-400-064	WS-400-082
15	35 mm	WS-400-029	WS-400-047	WS-400-065	WS-400-083
16	40 mm	WS-400-030	WS-400-048	WS-400-066	WS-400-084

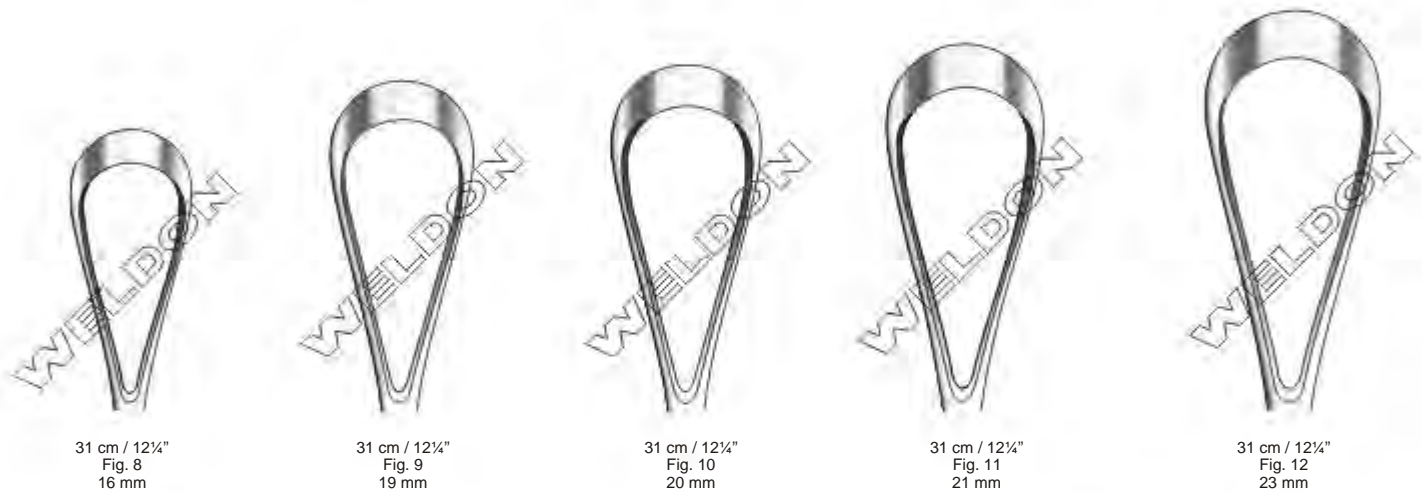
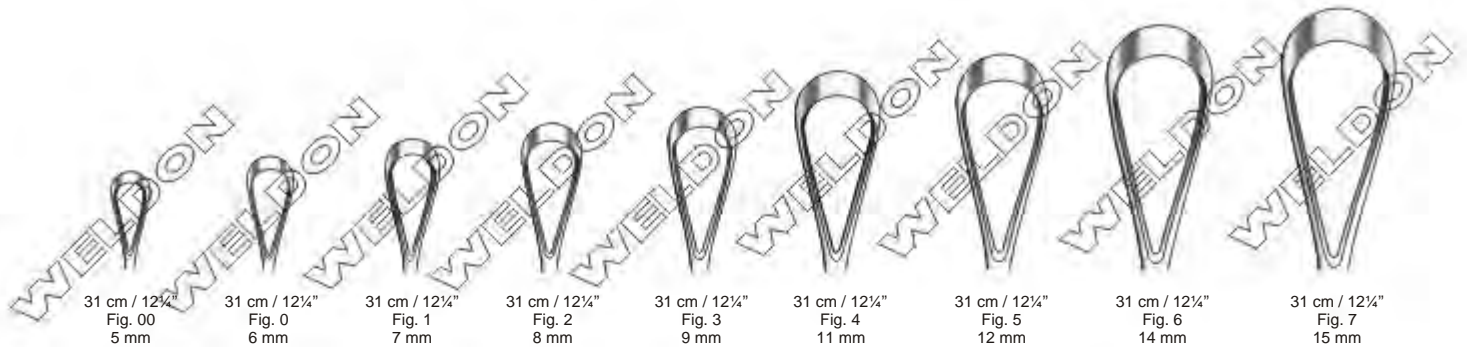

Recamier-Sims-Bumm

Uterine Scoops | Cucharillas Uterinas | Uteruslöffel

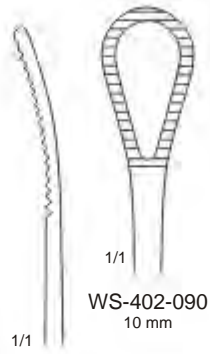

Gourdet  
28 cm / 11"

Greene  
28 cm / 11"  
Malleable, Blunt

Sims (Herrera)  
WS-402-093  
25 cm / 10"



1/1

WS-403-094  
9.8 x 6.8 mm



1/1

WS-403-100  
9.8 x 6.8 mm



1/1

WS-403-095  
11.6 x 8.3 mm



1/1

WS-403-101  
11.6 x 8.3 mm



1/1

WS-403-096  
13.2 x 10.0 mm



1/1

WS-403-102  
13.2 x 10.0 mm



1/1

WS-403-097  
16 x 11.6 mm



1/1

WS-403-103  
16 x 11.6 mm



1/1

WS-403-098  
18 x 12.6 mm



1/1

WS-403-104  
18 x 12.6 mm



1/1

WS-403-099  
20 x 13.8 mm



1/1

WS-403-105  
20 x 13.8 mm



Simon  
25 cm / 10"  
Sharp, Rigid



Schroeder  
31 cm / 12¼"  
Sharp, Rigid

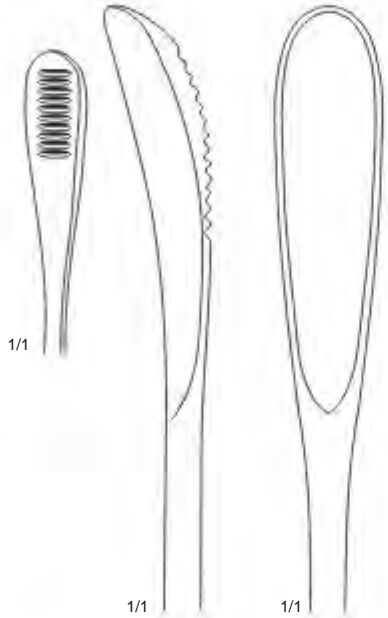

1/1

1/1

1/1

WS-404-106  
Fig. 1  
14 mm

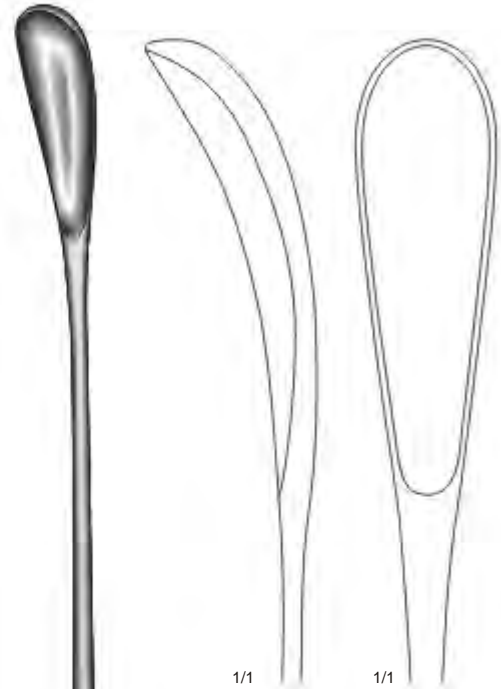

1/1

1/1

19 mm



1/1  
WS-404-107  
Fig. 2  
18 mm



1/1  
WS-404-108  
Fig. 3  
21 mm



Wallich  
WS-404-109  
42 cm / 16½"



Auxiliar Forceps  
WS-405-001  
36 cm / 14 1/4"

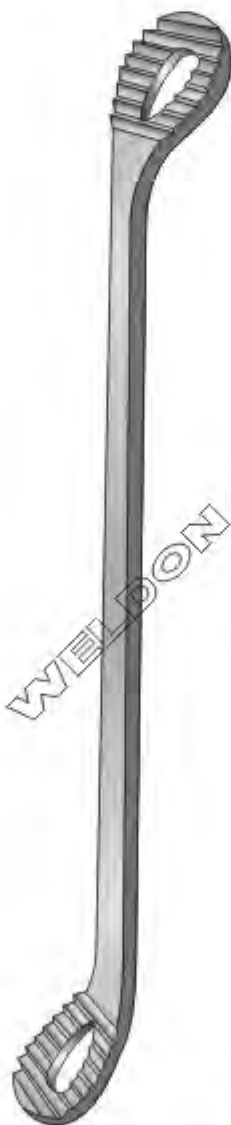

Sims  
WS-405-002  
26 cm / 10 1/2"  
Vaginal Depressor



Braun  
WS-405-003  
31 cm / 12 1/8"



Smellie  
WS-405-004  
27 cm / 10 3/4"

Placenta and Ovum Forceps | Pinzas Para Aborto | Abortuszangen



Winter  
28 cm / 11"



WS-406-005  
Fig. 1



WS-406-006  
Fig. 2



WS-406-007  
Fig. 1



WS-406-008  
Fig. 2



Ovum Forceps  
WS-406-009  
24 cm / 9½"  
Straight



Placenta & Ovum Forceps  
WS-406-010  
32 cm / 12¼"  
Curved

Uterine Tenaculum Forceps | Pinzas Para Cuello Uterino | Hakenzangen

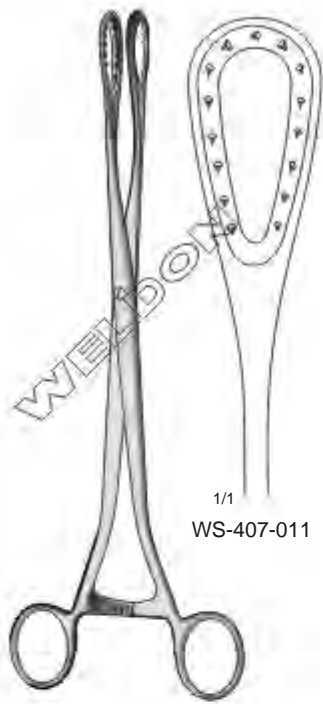

1/1  
WS-407-011

Saenger  
27 cm / 10½"

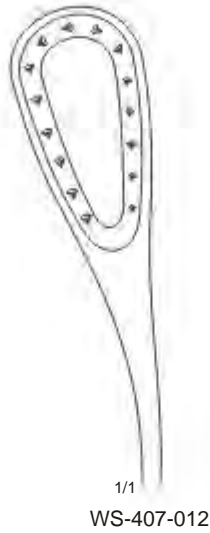

1/1  
WS-407-012

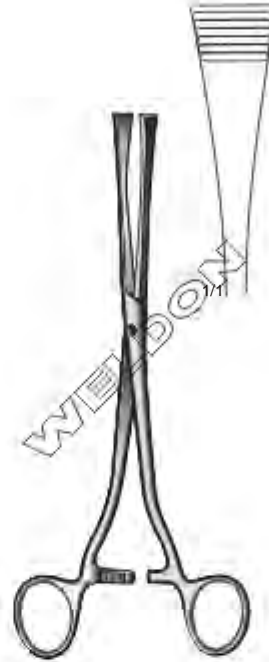

Green-Armytage  
WS-407-013  
21 cm / 8¼"  
Uterine Clamps



Selheim  
WS-407-014  
32 cm / 12½"  
Obstetrical Lever



Staude Moore  
WS-407-015  
17 cm / 6¾"  
Strong Pattern



Barrett  
WS-407-016  
18 cm / 7"



## Uterine Tenaculum Forceps | Pinzas Para Cuello Uterino | Hakenzangen



Pozzi  
WS-408-017  
25.5 cm / 10¼"



Duplay  
WS-408-018  
25.5 cm / 10"

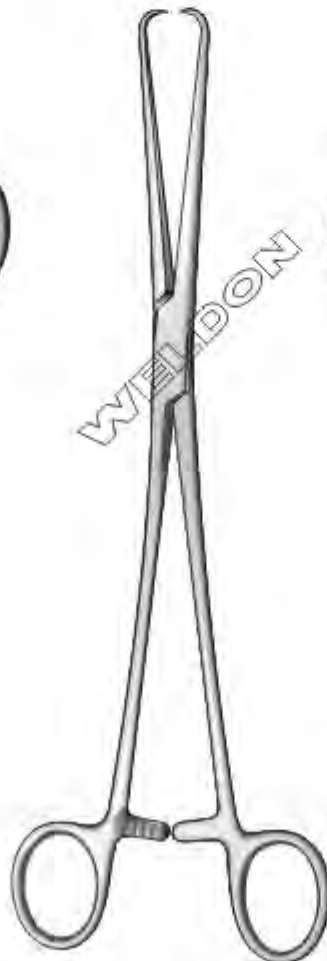

Schröder  
WS-408-019  
25 cm / 10"



Braun  
WS-408-020  
26 cm / 10¼"

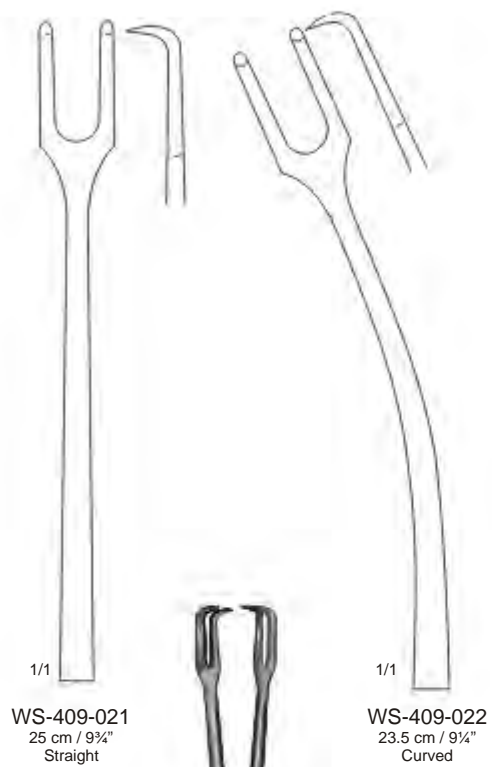

Schröder



Teale  
WS-409-023  
23 cm / 9"

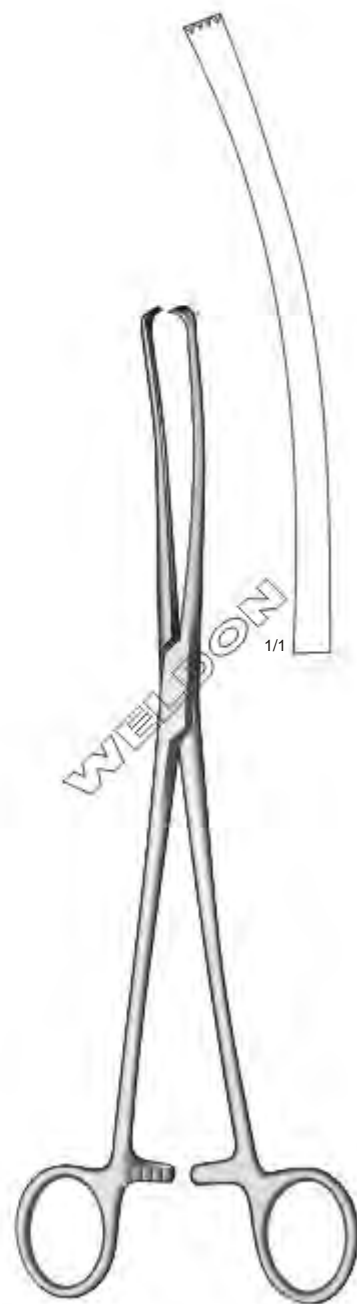

Lova  
WS-409-024  
26 cm / 10 1/4"

Uterine Tenaculum Forceps | Pinzas Para Cuello Uterino | Hakenzangen

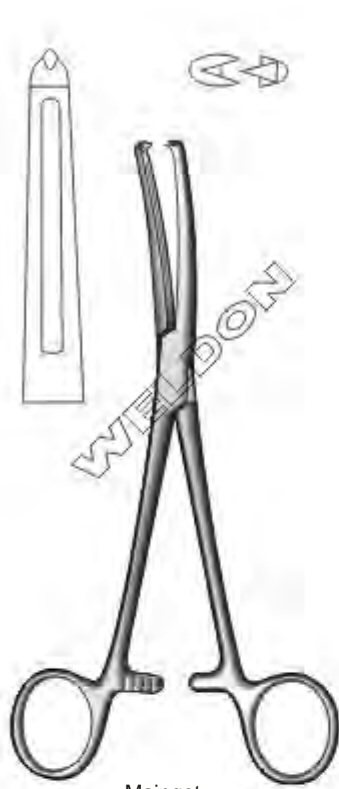

**Maingot**  
WS-410-025  
20.5 cm / 8"  
Hysterectomy Forceps

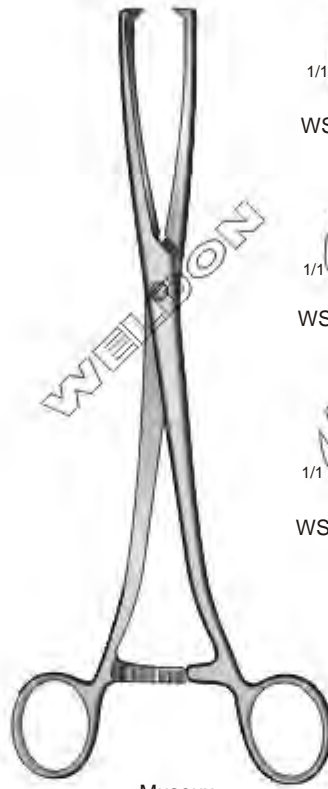

**Museux**  
24 cm / 9 1/2"

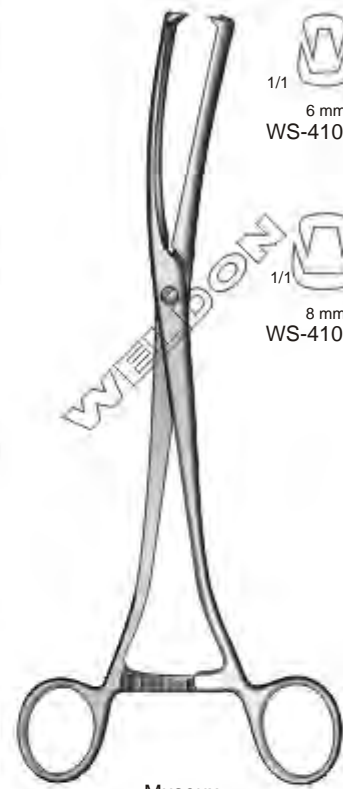

**Museux**  
24 cm / 9 1/2"  
Curved Sideways

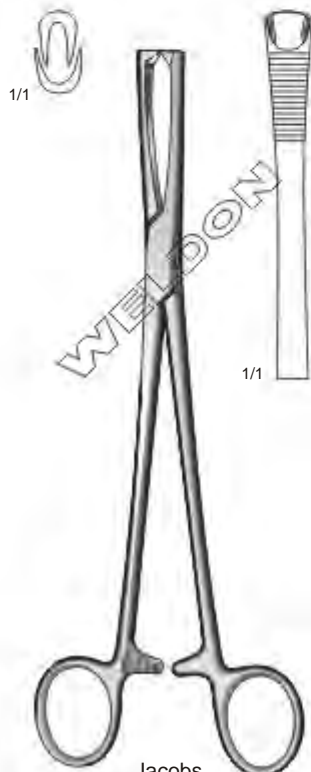

**Jacobs**  
WS-410-031  
21 cm / 8 1/4"

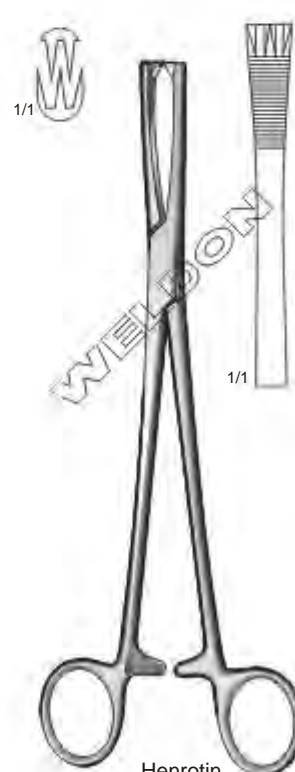

**Henrotin**  
WS-410-032  
20.5 cm / 8"

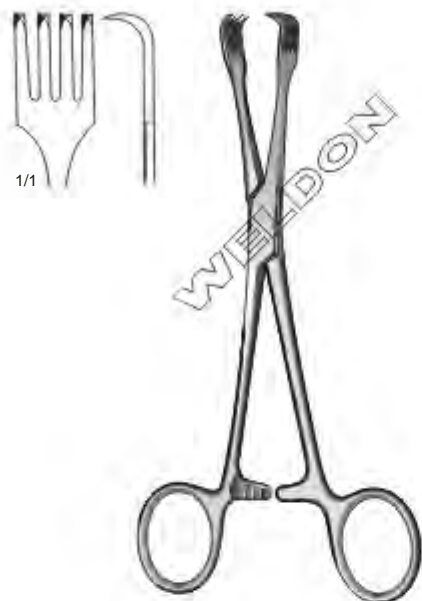

Braun  
WS-411-033  
16 cm / 6¼"

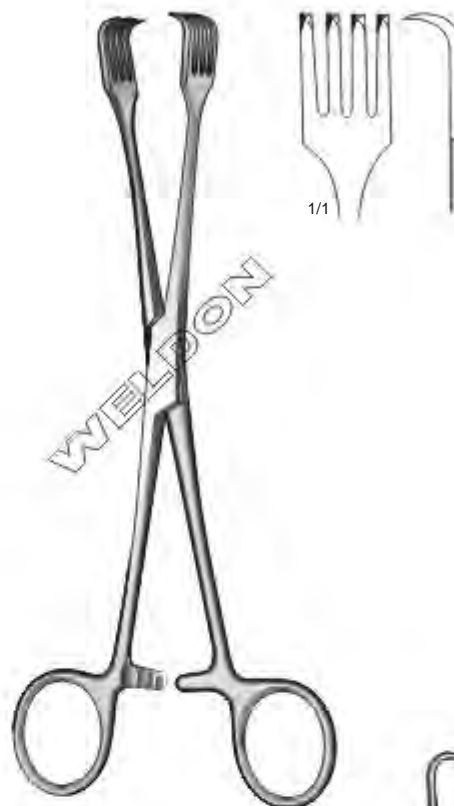

Czerny  
WS-411-034  
21 cm / 8¼"

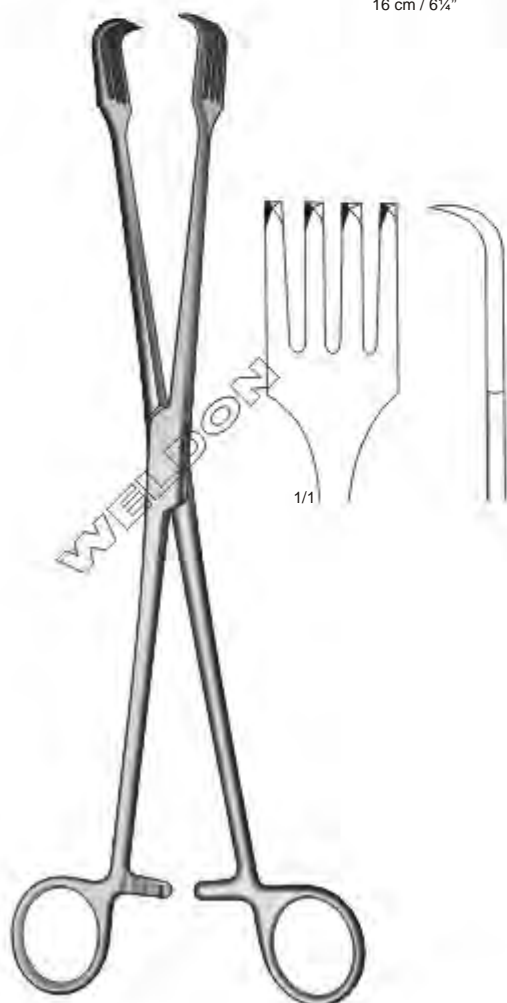

Tanaculum  
WS-411-035  
26 cm / 10¼"



Beacham  
WS-411-036  
26 cm / 10¼"  
Amniotome



Skene  
WS-411-037  
24 cm / 9½"

Uterine Polypus Forceps | Pinzas Para Pólipos Uterinos | Uterus-Polypenzangen

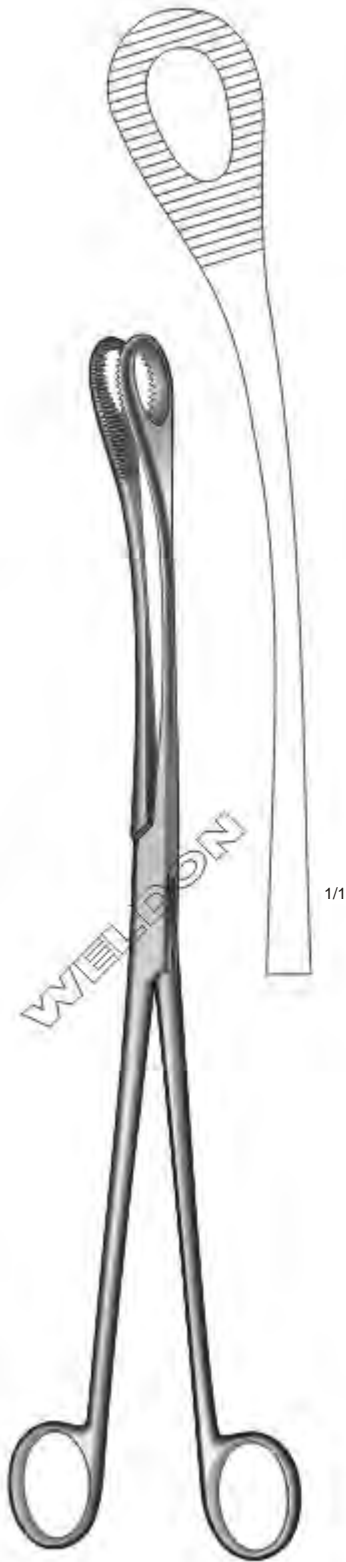

Kelly  
WS-412-038  
32 cm / 12½"



Noto  
WS-412-039  
27 cm / 10¾"



Doyen  
WS-412-040  
20 cm / 8"



Special Model  
WS-413-041  
34 cm / 13½"  
cm & inch Scale



Collin  
WS-413-042  
35 cm / 13¼"  
cm Scale

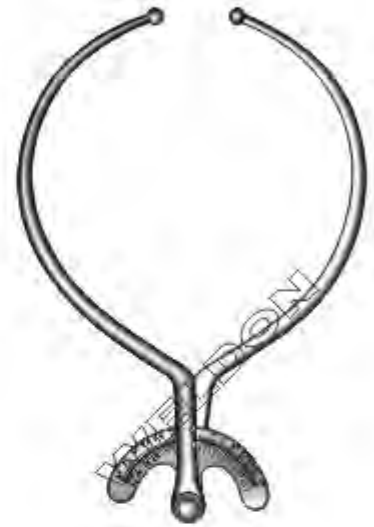

Breisky  
WS-413-043  
33 cm / 13"  
cm & inch Scale



Doyen  
WS-413-044  
17 cm / 6¾"



Doyen  
WS-413-045  
14.5 cm / 5½"

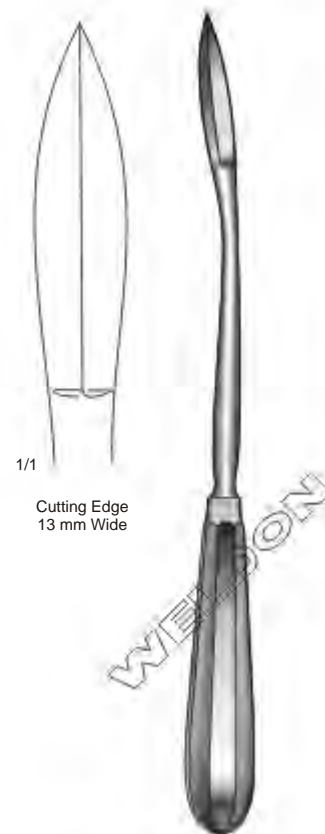

Segond  
WS-413-046  
28 cm / 11"

Uterine Seizing Forceps | Histerólabos | Uterusfasszange

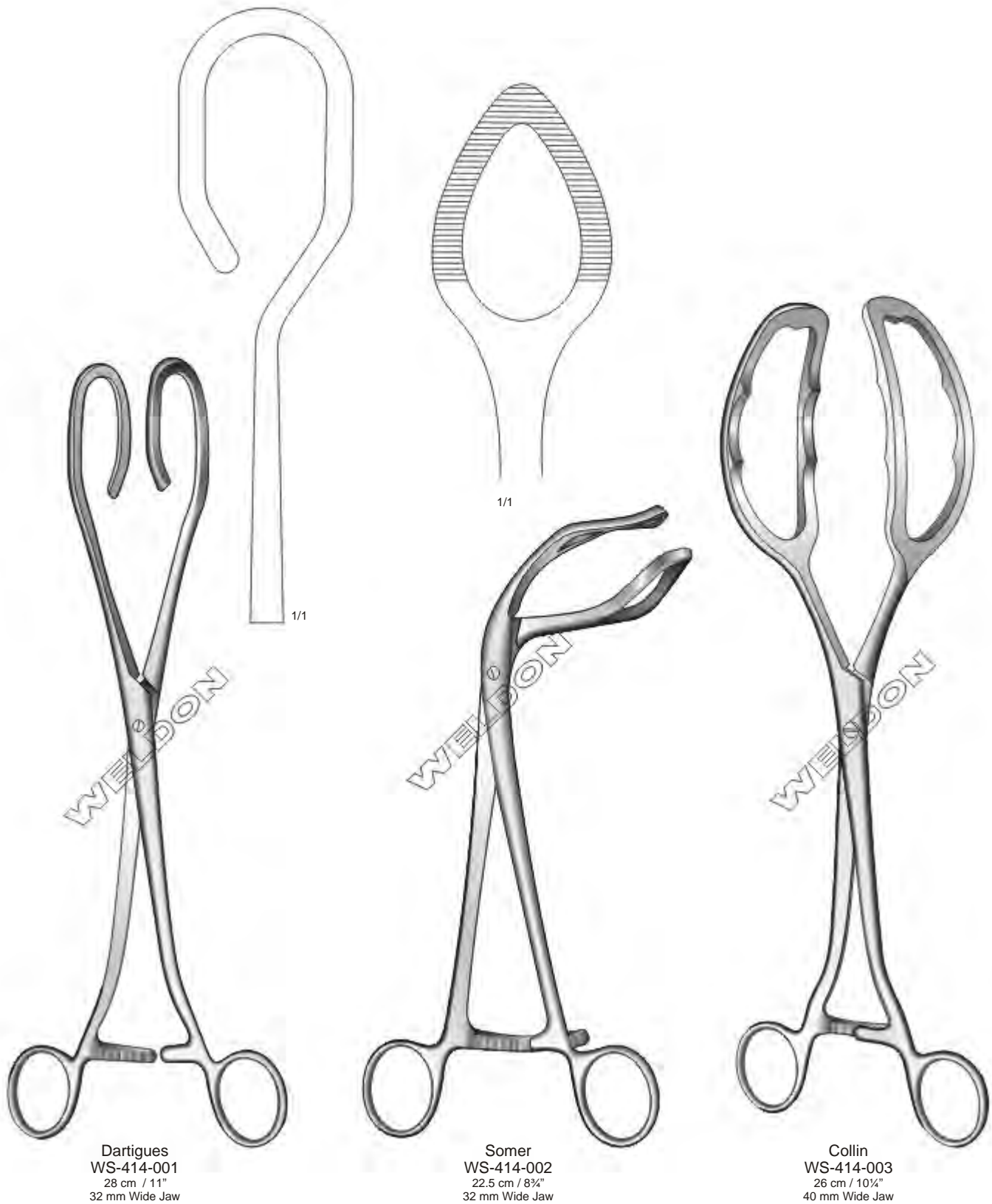

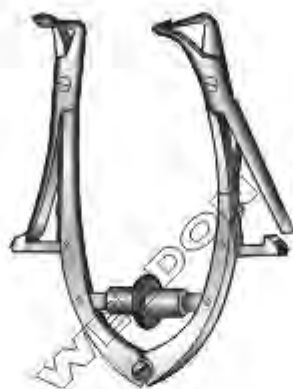

Friedman  
WS-415-001  
10 cm / 4"  
Retractor, Self Retaining,  
For Perineorrhaphy

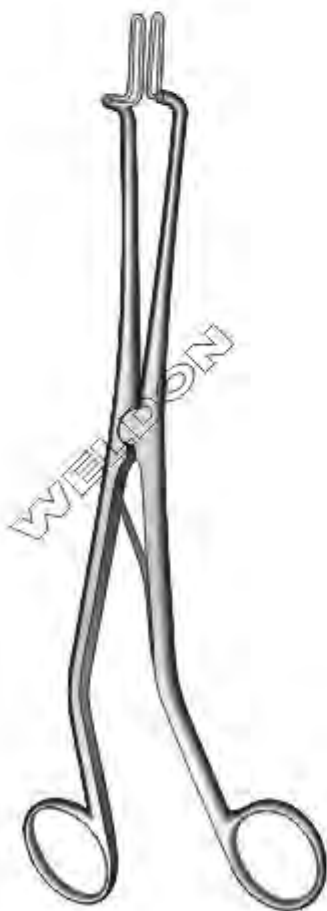

Kogan  
WS-415-002  
24.5 cm / 9¾"



Kogan  
WS-415-003  
24.5 cm / 9¾"  
With Graduated Ratchet  
And Fixing Screw



**Uterine Biopsy Forceps | Pinzas Para Biopsia | Probeexzisionszangen**

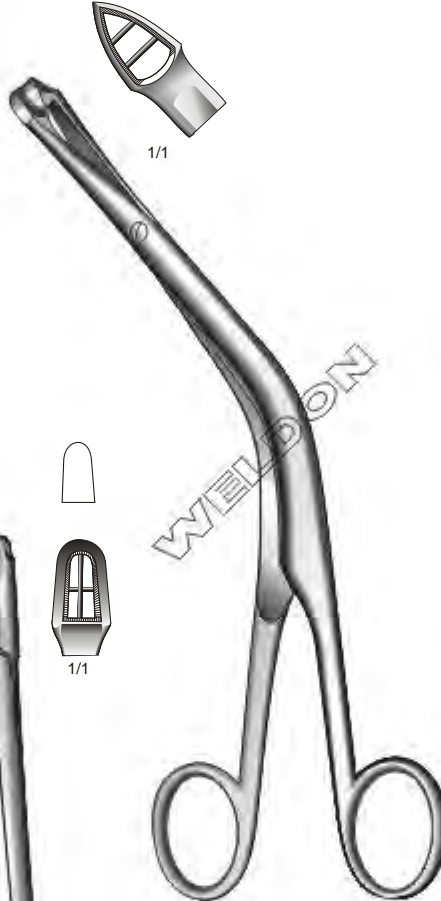

**Gelhorn**  
 WS-416-001  
 24 cm / 9½"  
 8.6 mm Wide Jaw



**Faure**  
 WS-416-002  
 21 cm / 8¼"  
 8.4 mm WideJaw

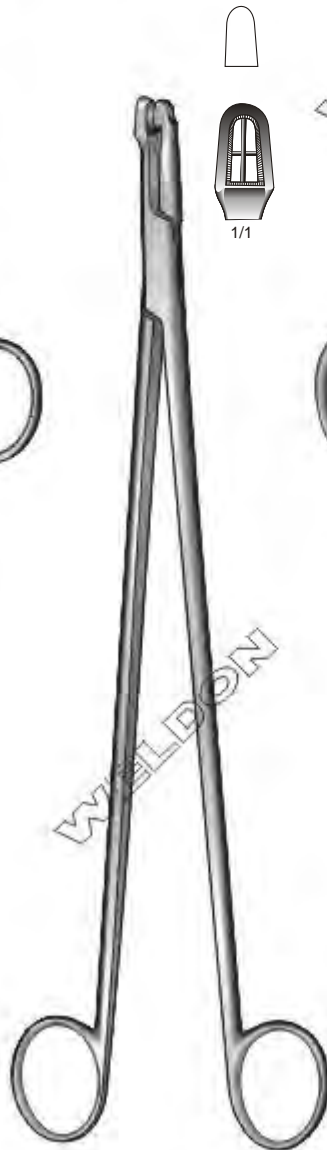

**Medina**  
 WS-416-002A  
 23 cm / 9"  
 Biopsy Forceps



**Schubert**  
 WS-416-003 21 cm / 8¼"  
 WS-416-004 29 cm / 11½"  
 4.8 mm Wide Jaw



**Thoms-Gaylor**  
 WS-416-005 21 cm / 8¼"  
 WS-416-006 24 cm / 9½"  
 Jaw Ø 5.6 mm

Uterine Biopsy Forceps | Pinzas Para Biopsia | Probeexzisionszangen

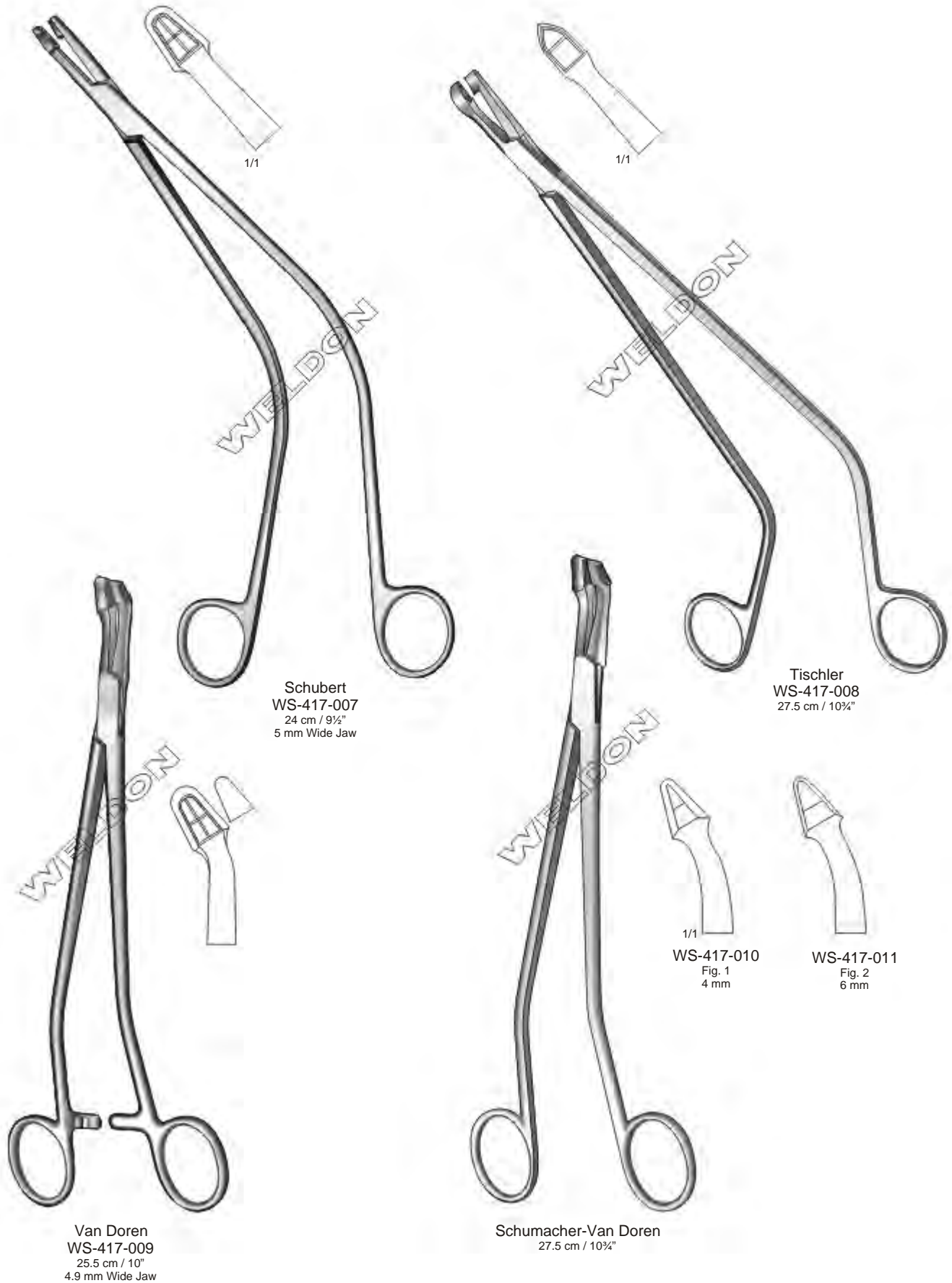

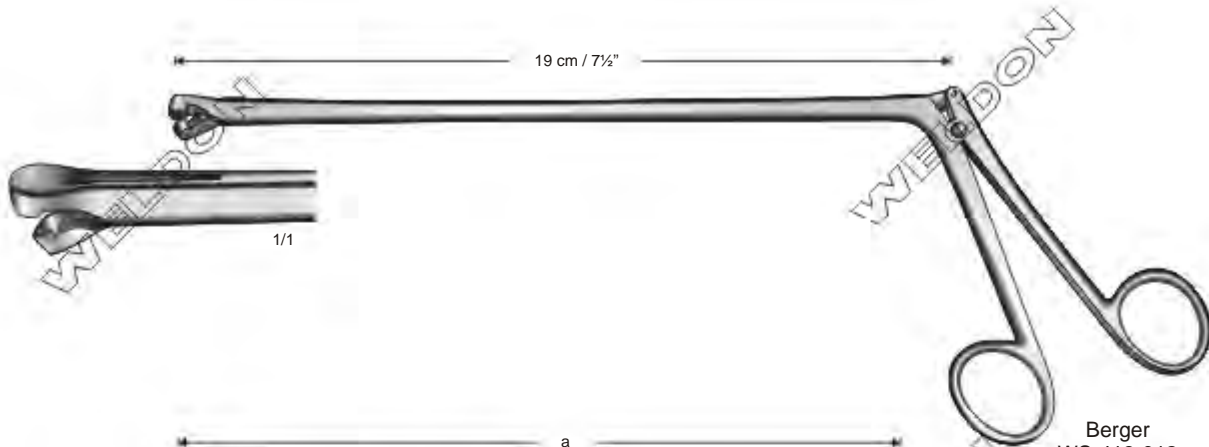
**Uterine Biopsy Forceps | Pinzas Para Biopsia | Probeexzisionszangen**

**Berger**  
WS-418-012

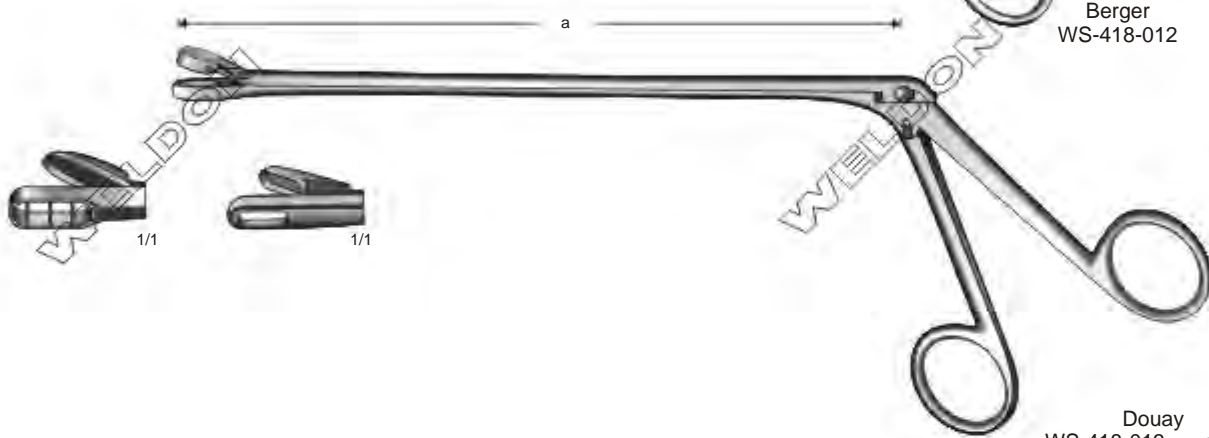

**Douay**  
 WS-418-013 a = 20 cm / 8"  
 WS-418-014 a = 25 cm / 10"  
 WS-418-015 a = 30 cm / 11 1/2"  
 WS-418-016 a = 35 cm / 13 1/4"  
 WS-418-017 a = 40 cm / 15 1/4"

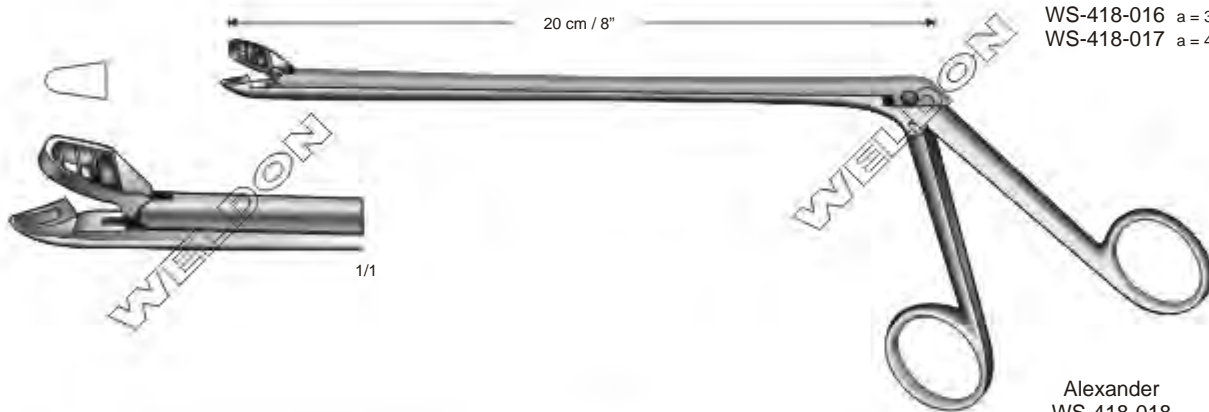

**Alexander**  
WS-418-018

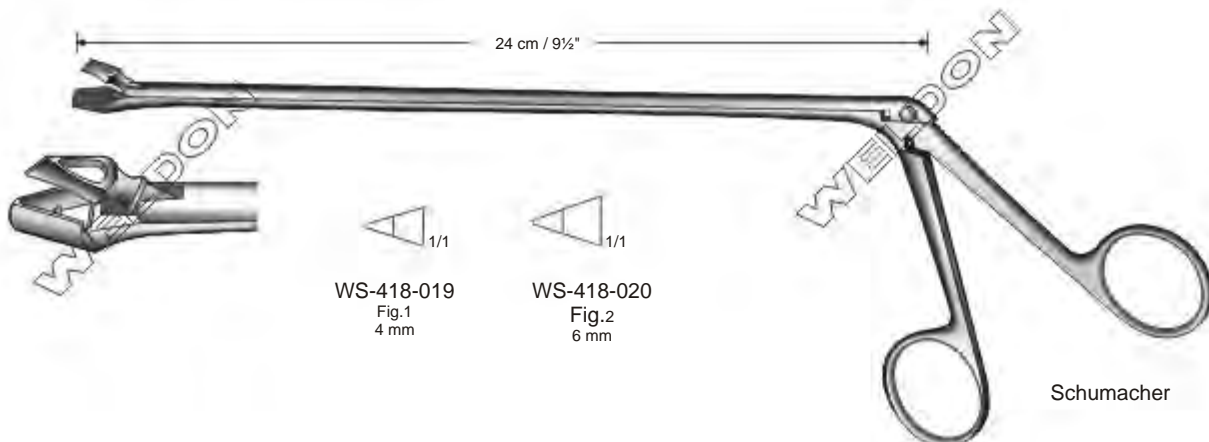

**Schumacher**

Uterine Biopsy Forceps | Pinzas Para Biopsia | Probeexzisionszangen

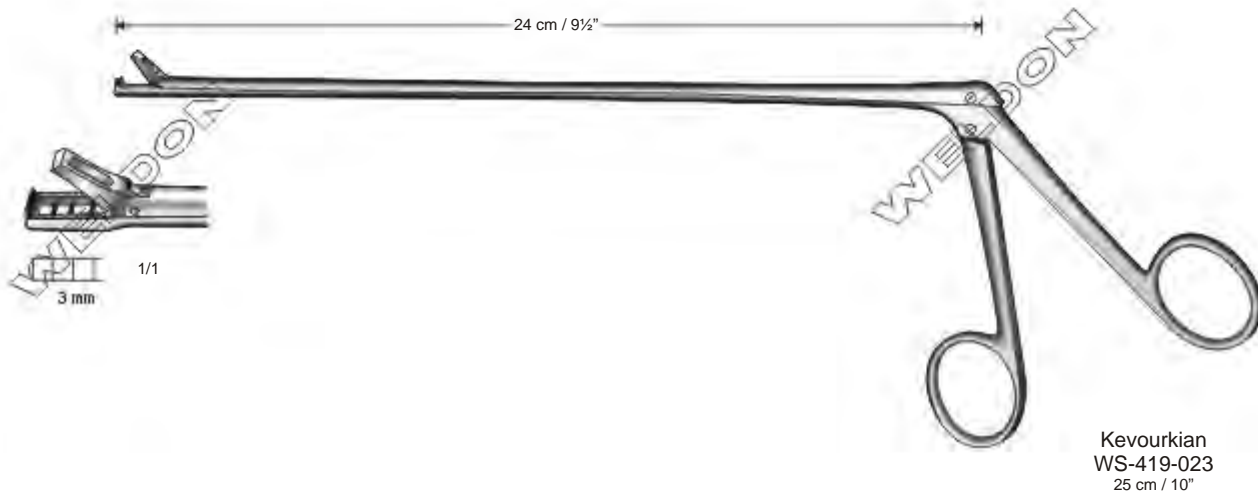

Tischler Biopsy Forceps | Tischler Pinzas Para Biopsia | Tischler Probeexzisionszangen

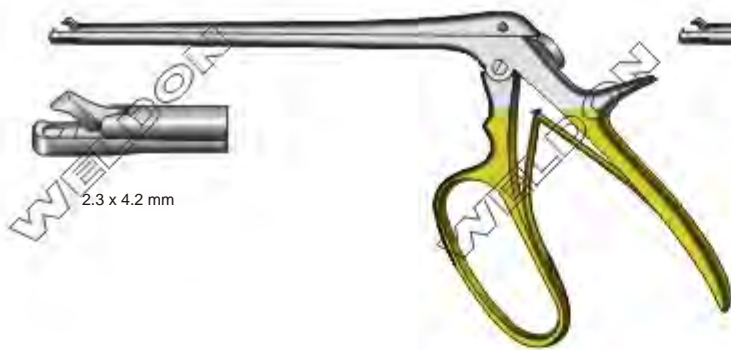

Baby Tischler Forceps  
WS-420-024

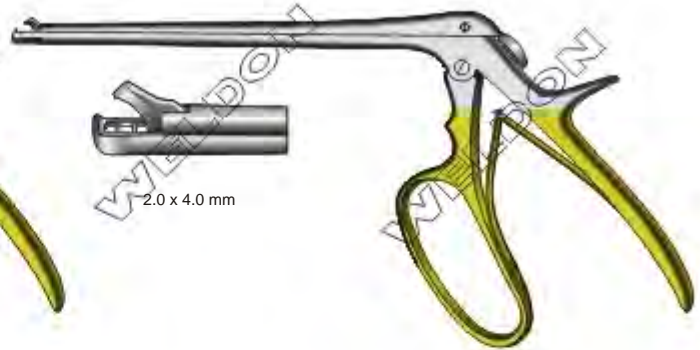

Mini Tischler Forceps  
WS-420-025

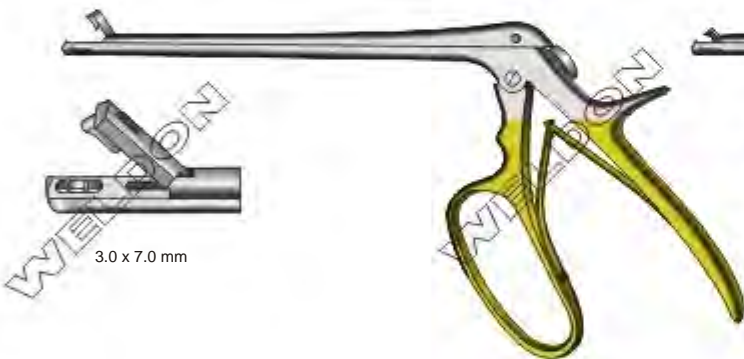

Morgan Tischler Forceps  
WS-420-026

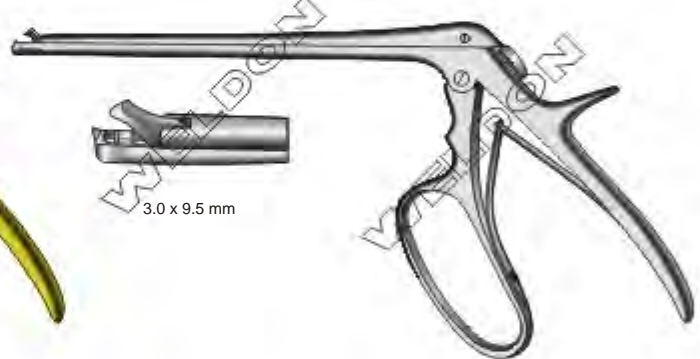

Kevorkian Tischler Forceps  
WS-420-027



Burke Tischler Forceps  
WS-420-028

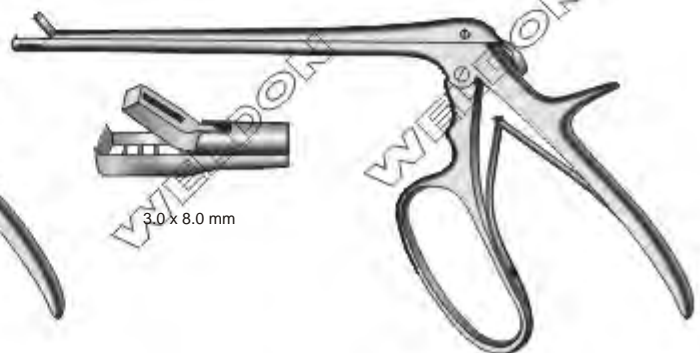

Kevorkian-Pacific Tischler Forceps  
WS-420-029



Naegele  
WS-421-003 36 cm / 14"  
WS-421-004 40 cm / 16"



Simpson  
WS-421-001  
31 cm / 12¼"

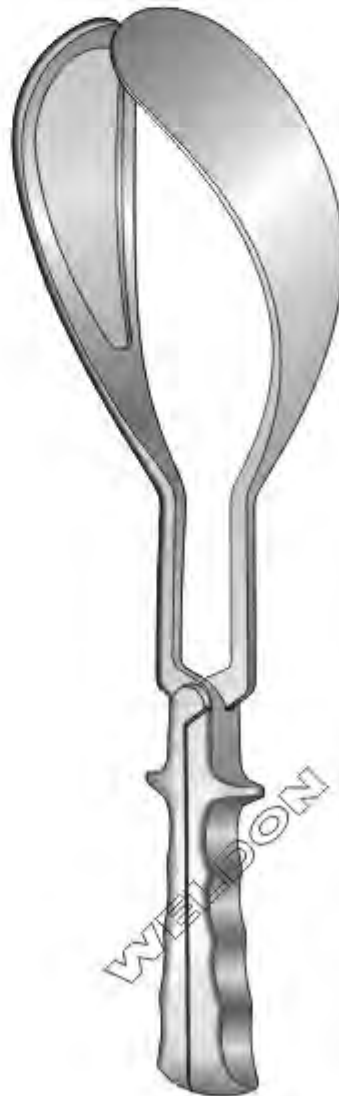

Simpson-Luikart  
WS-421-005  
36 cm / 14"

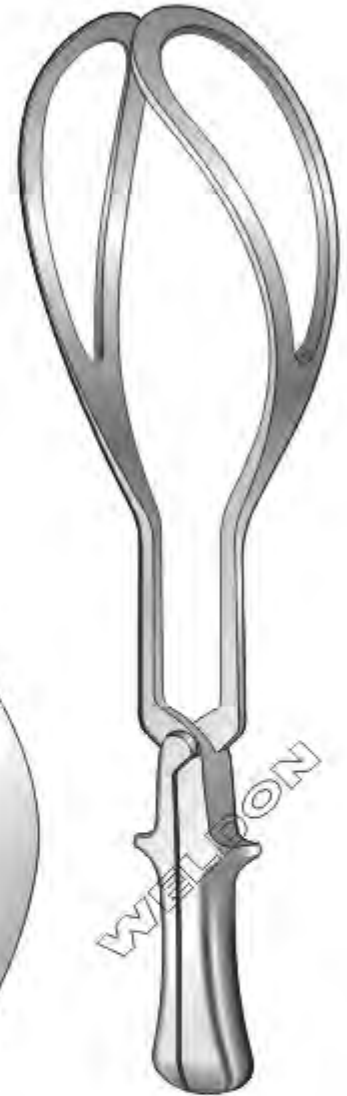

Simpson-Braun  
WS-421-002  
36 cm / 14"



DeLee  
WS-422-006  
30 cm / 12"



Elliot  
WS-422-007  
32 cm / 12½"  
WS-422-008  
38 cm / 15"



DeLee  
WS-422-009 36 cm / 14"  
WS-422-010 39 cm / 15½"

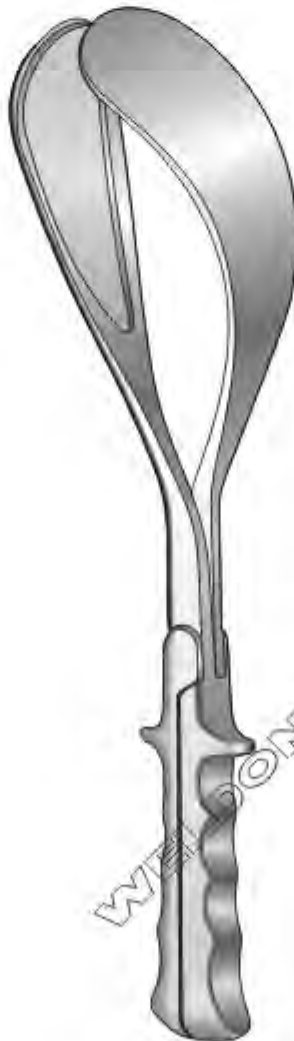

McLean-Luikart  
WS-422-011  
38 cm / 15"

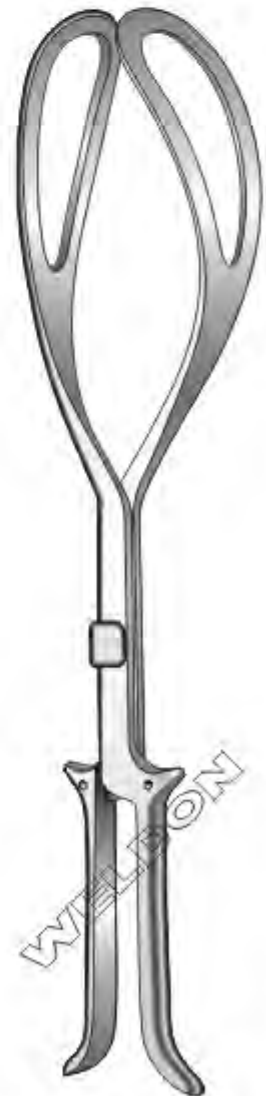

Kielland  
WS-422-012  
41 cm / 16"

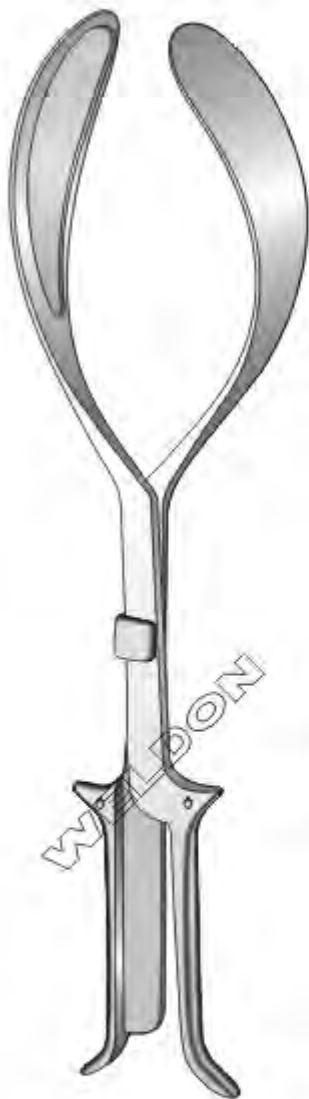

Kielland-Luikart  
WS-423-013  
40 cm / 15½"



Piper  
WS-423-014  
44 cm / 17¼"

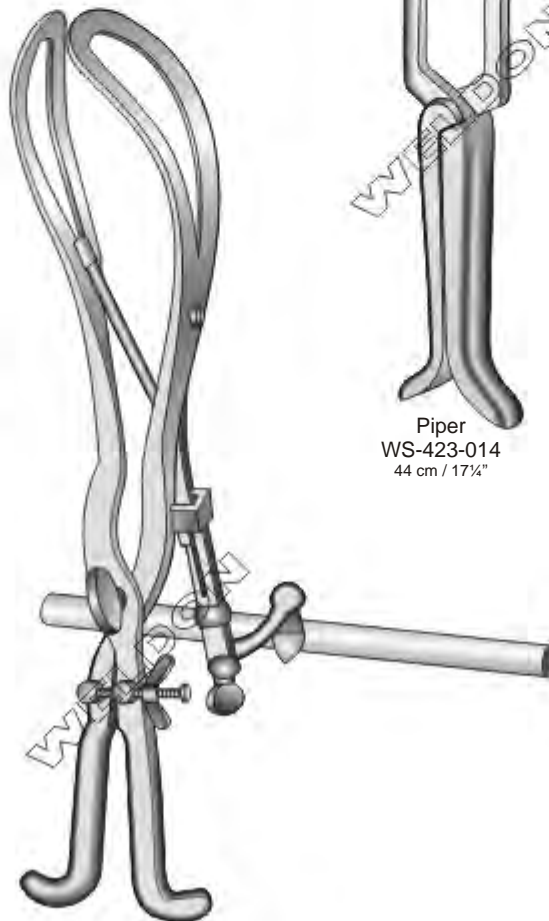

Tarnier  
WS-423-015  
40 cm / 15½"  
With Traction Handle



Wrigley  
WS-423-016  
28 cm / 11"





**Episiotomy set  
WS-424-017**

In Canvas Roll, Stored In Metal Case 200 x 100 x 30 mm  
Consisting of  
1 Dressing Forceps 14.5 cm  
1 Tissue Forceps 14.5 cm  
1 Mathieu Needle Holder 17 cm  
1 Braun-Stadler Episiotomy Scissors 15 cm  
1 Tissue Scissors 14.5 cm  
1 Kocher Hemostatic Forceps 14 cm



**Mod. Tübingen  
WS-424-018**

Midwifery Set in Canvas Roll, Consisting of:  
1 Tissue Forceps 14.5 cm  
1 Dressing Forceps 14.5 cm  
1 Braun-Stadler Episiotomy Scissors 15 cm  
1 Nail File 10 cm  
1 Tissue Scissors, Curved 14.5 cm  
1 Nail Scissors 10.5 cm  
1 Busch Funicular Scissors 16 cm  
2 Rochester-Pean Hemostatic Forceps 16 cm  
1 Gross Sponge Forceps 20 cm  
1 Metal Catheter 12 French  
1 Funnel-Shaped Stethoscope  
1 Tape Measure, Linen, 1.5 m